

Panasonic®

Basic Operating Instructions

Digital Camera

Model No. **DC-FZ82D**

LUMIX



Please read these instructions carefully before using this product, and save this manual for future use.

More detailed operating instructions are available in "Operating Instructions for advanced features (PDF format)". To read it, download it from the website. (→56)

Web Site: <http://www.panasonic.com>

Dear Customer,

We would like to take this opportunity to thank you for purchasing this Panasonic Digital Camera. Please read these Operating Instructions carefully and keep them handy for future reference. Please note that the actual controls and components, menu items, etc. of your Digital Camera may look somewhat different from those shown in the illustrations in these Operating Instructions.

Carefully observe copyright laws.

- Recording of pre-recorded tapes or discs or other published or broadcast material for purposes other than your own private use may infringe copyright laws. Even for the purpose of private use, recording of certain material may be restricted.

Information for Your Safety

WARNING:

To reduce the risk of fire, electric shock or product damage,

- Do not expose this unit to rain, moisture, dripping or splashing.
- Use the recommended accessories.
- Do not remove covers.
- Do not repair this unit by yourself. Refer servicing to qualified service personnel.

■ Product identification marking

Product	Location
Digital camera	Bottom

■ About the battery pack

CAUTION

- Danger of explosion if battery is incorrectly replaced. Replace only with the type recommended by the manufacturer.
 - When disposing of the batteries, please contact your local authorities or dealer and ask for the correct method of disposal.
-
- Do not heat or expose to flame.
 - Do not leave the battery(ies) in a car exposed to direct sunlight for a long period of time with doors and windows closed.
 - Do not expose to low air pressure at high altitudes.
 - Do not expose to extremely low air pressure, as this may result in explosions or leakage of flammable liquids and gases.

Warning

Risk of fire, explosion and burns. Do not disassemble, heat above 60 °C or incinerate.

■ Cautions for Use

- Use a High Speed HDMI micro cable (Type D–Type A plug) with the length less than 3 m (9.8 feet).

Keep this unit as far away as possible from electromagnetic equipment (such as microwave ovens, TVs, video games etc.).

- If you use this unit on top of or near a TV, the pictures and/or sound on this unit may be disrupted by electromagnetic wave radiation.
- Do not use this unit near cell phones because doing so may result in noise adversely affecting the pictures and/or sound.
- Recorded data may be damaged, or pictures may be distorted, by strong magnetic fields created by speakers or large motors.
- Electromagnetic wave radiation may adversely affect this unit, disturbing the pictures and/or sound.
- If this unit is adversely affected by electromagnetic equipment and stops functioning properly, turn this unit off and remove the battery or disconnect AC adaptor. Then reinsert the battery or reconnect AC adaptor and turn this unit on.

Do not use this unit near radio transmitters or high-voltage lines.

- If you record near radio transmitters or high-voltage lines, the recorded pictures and/or sound may be adversely affected.

-
- To clean your camera, remove the battery, card, or disconnect the power plug from the outlet, and wipe with a soft, dry cloth.
 - Do not press the monitor with excessive force.
 - Do not press the lens with excessive force.
 - Do not allow camera to come into contact with pesticides or volatile substances (can cause surface damage or coating to peel).
 - Do not keep rubber or plastic products in contact with the camera for a long period of time.
 - Do not use solvents such as benzene, thinner, alcohol, kitchen detergents, etc., to clean the camera, since it may deteriorate the external case or the coating may peel off.
 - Do not leave the camera with the lens facing the sun, as rays of light from the sun may cause it to malfunction.
 - Do not extend the supplied cord or cable.
 - While the camera is accessing the card (for operations such as picture writing, reading, deletion, or formatting), do not turn off the camera or remove the battery or card.
Furthermore, do not subject the camera to vibration, impact or static electricity.
 - The data on the card may be damaged or lost due to electromagnetic waves, static electricity or breakdown of the camera or the card. We recommend storing important data on a PC etc.
 - Do not format the card on your PC or other equipment. Format it on the camera only to ensure proper operation.
-

-
- **The battery is not charged when the camera is shipped. Charge the battery before use.**
 - **The battery is a rechargeable lithium ion battery. If the temperature is too high or too low, the operating time of the battery will become shorter.**
 - The battery becomes warm after using and during and after charging. The camera also becomes warm during use. This is not a malfunction.
 - **Do not leave any metal items (such as clips) near the contact areas of the power plug or near the batteries.**
 - Store the battery in a cool and dry place with a relatively stable temperature. (Recommended temperature: 15 °C to 25 °C (59 °F to 77 °F), Recommended humidity: 40%RH to 60%RH)
 - **Do not store the battery for a long time while fully charged.** When storing the battery for a long period of time, we recommend charging it once a year. Remove the battery from the camera and store it again after it has completely discharged.
 - Place the removed battery in a plastic bag, etc., and keep away from metallic objects (clips, etc.) for storage or transport.
 - When disposing of the batteries, please contact your local authorities or dealer and ask for the correct method of disposal.
 - When [Sleep Mode] in [Power Save Mode] is set to [OFF], the power consumption of this camera may be increased.
 - For more information about the energy efficiency of the product, please visit our website, www.panasonic.com, and enter the model number in the search box.
-

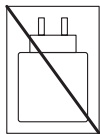

The power delivered by the charger must be between min. 2.5 Watts required by this product, and max. 15 Watts in order to achieve the maximum charging speed.



These symbols indicate separate collection of waste electrical and electronic equipment or waste batteries.

More detailed information is contained in "Operating Instructions for advanced features (PDF format)".

Contents

Information for Your Safety	2
-----------------------------------	---

Preparations

Before use	8
Standard accessories	9
Names and Functions of Main Parts	10
Attaching the Lens Cap/ Shoulder Strap	12
Inserting and removing the battery or SD memory card (optional).....	14
Charging the battery	15
Setting the clock	18

Basics

Basic operations	19
Setting the menu	25

Recording

Taking pictures with automatic settings (Intelligent Auto Mode)	26
Taking pictures with Manual Focus.....	27
Taking pictures with Exposure Compensation	28
Recording with the 4K Photo function ...	29
Adjusting the focus after recording ([Post Focus] / [Focus Stacking]).....	32
Taking Pictures While Adjusting a Setting Automatically (Bracket Recording).....	35
Recording Motion Picture/ 4K Motion Picture.....	36
[4K Live Cropping]	38

Playback

Viewing your pictures	40
[Light Composition]	41

Menu

Menu list.....	43
----------------	----

Others

Downloading software.....	45
List of monitor/viewfinder displays.....	46
Q&A Troubleshooting	50
Specifications	52
Digital Camera Accessory System	55
Reading the Operating Instructions (PDF format)	56

■ Recording mode icons

Recording mode:   **P** **A** **S** **M**  **SCN** 

In Recording modes that show icons in black, you can select and execute indicated menus and functions.

C1**C2** has different functions depending on the recording mode that is registered.



■ Symbols used in this document

MENU Indicates that the menu can be set by pressing [MENU/SET] button.

In this Operating Instructions, steps for setting a menu item are described as follows:

MENU →  **[Rec]** → **[Quality]** → **[.:.]**

- In this manual, dial and lever operations are illustrated as below.

Rotate the rear dial	
Press the rear dial	
Rotate the zoom lever	

Before use

■ Camera handling

Keep the camera away from excessive vibration, force, or pressure.

- Avoid using the camera under the following conditions, which may damage the lens, monitor, viewfinder, or camera body.

This may also cause the camera to malfunction or prevent recording.

- Dropping or hitting the camera against a hard surface
- Pushing with excessive force on the lens or monitor

Do not hold the lens barrel as you take pictures. There is a risk that your finger will be trapped as the lens retracts.

When camera is not in use or when using the playback feature, ensure that the lens is in the stored position.

There are times when rattling sounds or vibrations will come from the camera, but these are due to the motion of the aperture, the zoom and the motor and do not indicate a defect.

The camera is not dust resistant, splash resistant, or waterproof.

Avoid using the camera in places with excessive dust or sand, or where water can come into contact with the camera.

■ Condensation (When the lens, the monitor, or viewfinder, is fogged up)

- Condensation may occur when the camera is exposed to sudden changes of temperature or humidity. Avoid these conditions, which may make the lens, monitor, or viewfinder dirty, cause mould, or damage the camera.
- If condensation does occur, turn off the camera and wait about two hours before using it. Once the camera adjusts to the surrounding temperature, the fogging will clear naturally.

■ About strong light beams such as laser light

- Do not irradiate the camera (lens) directly with strong light beams such as laser beams.
Doing so may damage the image sensor and cause the camera to malfunction.

Standard accessories

Check that all the accessories are supplied before using the camera. Product numbers correct as of June 2024. These may be subject to change.

Battery pack

DMW-BMB9E



- Charge the battery before use.
- Battery pack is indicated as battery pack or battery in the text.

**Lens Cap/
Lens Cap String**

VYQ8752

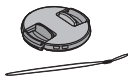

Shoulder Strap

VFC4453



- **Cards are optional.** (SD Memory Card, SDHC Memory Card and SDXC Memory Card are indicated as card in the text.)
 - This unit is compatible with UHS-I UHS Speed Class 3 standard SDHC/SDXC memory cards.
 - The following SD standard-based cards can be used.
SD Memory Card/SDHC Memory Card/SDXC Memory Card (Maximum 512 GB)
 - Depending on recording conditions, the required card differs.
- Consult the dealer or Panasonic if you lose the supplied accessories. (You can purchase the accessories separately.)
- Please dispose of all packaging appropriately.
- The illustrations and screens in this manual may differ from the actual product.
- A lens hood is not supplied with this unit.

Names and Functions of Main Parts

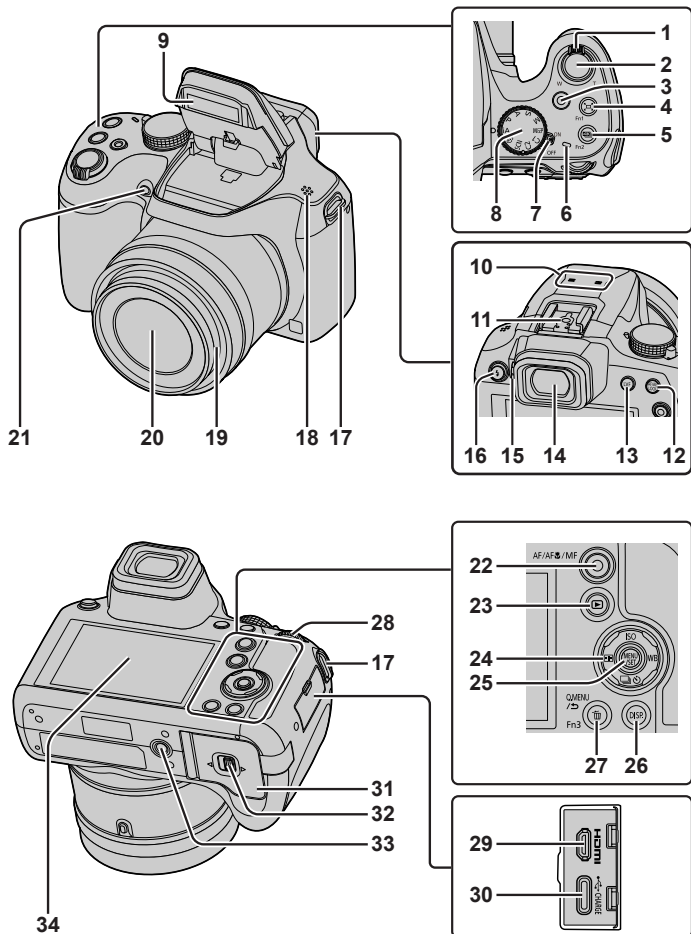

- 1 Zoom lever (→19)
- 2 Shutter button (→20)
- 3 Motion picture button (→36)
- 4 [ZOOM] ([Zoom Compose Assist] button (→19) / [Fn1] button
- 5 [4K] (4K photo mode) button (→29) / [Fn2] button
- 6 Charging lamp (→17)
- 7 Camera [ON/OFF] switch (→18)
- 8 Mode dial (→21)
- 9 Flash
- 10 Stereo microphone
- 11 Hot shoe
- 12 [AF/AE LOCK] button
- 13 [LVF] button (→22)
- 14 Viewfinder (→22, 46)
- 15 Diopter adjustment dial (→22)
- 16 [FLASH] (Flash open) button
 - The flash opens, and recording with the flash becomes possible.
- 17 Shoulder strap eyelet (→12, 13)
- 18 Speaker
- 19 Lens barrel
- 20 Lens
- 21 Self-timer indicator / AF Assist Lamp
- 22 [AF/AF-LOCK/MF] button (→22)
- 23 [PLAY] (Playback) button (→40)
- 24 Cursor button (→23)
- 25 [MENU/SET] button (→25)
- 26 [DISP.] button
 - Use this to change display.
- 27 [Q.MENU/ESC] (Cancel) button / [DELETE] (Delete) button (→40) / [Fn3] button
 - You can easily call some of the menu items and set them during recording.
- 28 Rear dial (→23)
- 29 [HDMI] socket
 - You can view pictures on a TV screen by connecting your camera to your TV with the HDMI micro cable.
- 30 [USB/CHARGE] socket (→16)
- 31 Card/Battery door (→14)
- 32 Release lever (→14)
- 33 Tripod mount
 - Do not attach this unit to tripods that have screws with a length of 5.5 mm (0.22 inch) or more. Doing so may damage this unit or the unit may not be secured properly on the tripod.
- 34 Touch screen (→24) / monitor (→46)

- [Fn4] to [Fn8] (→24) are touch icons. They are displayed by touching the [Fn] tab on the recording screen.

Attaching the Lens Cap/Shoulder Strap

Attaching the Lens Cap

Cover the lens with the lens cap to protect it when you are not taking pictures.

- Do not hang or swing around the camera with the lens cap string.
- Make sure to detach the lens cap when turning this unit on.
- Be careful that the lens cap string does not become entangled with the shoulder strap.

1 Pass the string through the shoulder strap eyelet on the camera

Ⓐ Shoulder strap eyelet

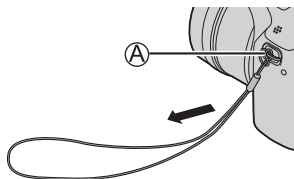

2 Pass the same string through the hole on the lens cap

①

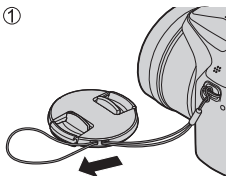

②

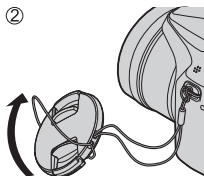

③

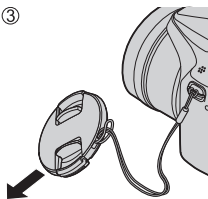

3 Attach the lens cap

Ⓑ Pinch here to attach or detach the cap.

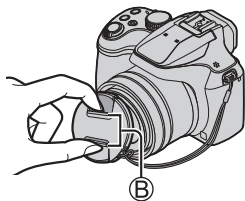

Attaching the Shoulder Strap

We recommend attaching the shoulder strap when using the camera to prevent it from dropping.

1 Pass the shoulder strap through the hole at the shoulder strap eyelet

- Attach the shoulder strap so that the “LUMIX” Logo is on the outside.

(A) Shoulder strap eyelet

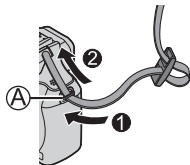

2 Pass the end of the shoulder strap through the stopper

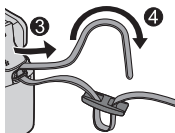

3 Pass the end of the shoulder strap through the hole on the other side of the stopper

(B) Pull the shoulder strap 2 cm (0.066 feet) or more.

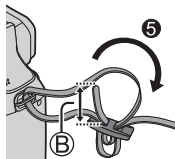

4 Pull the shoulder strap and then check that it will not come out

- Perform steps 1 to 4 and then attach the other side of the shoulder strap.
- Use the shoulder strap around your shoulder.
 - Do not wrap the strap around your neck. It may result in injury or accident.
- Do not leave the shoulder strap where an infant can reach it.
 - It may result in an accident by mistakenly wrapping around the neck.

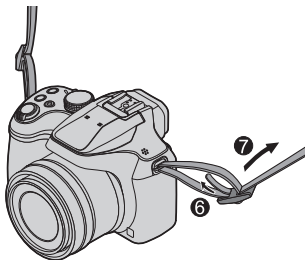

Inserting and removing the battery or SD memory card (optional)

Make sure that the camera is turned off.

- 1 Slide the release lever (A) to the [OPEN] position and open the card/battery door**
- 2 Insert the battery and card, making sure that their orientation is correct**
 - Battery: Insert the battery all the way firmly and check that it is locked by lever (B).
 - Card: Insert the card all the way firmly until it clicks. Do not touch the terminal.
- 3 Close the door**
Slide the release lever to the [LOCK] position.

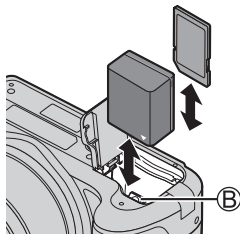
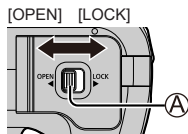

■ To remove

• To remove battery

Move lever (B) in direction of arrow.

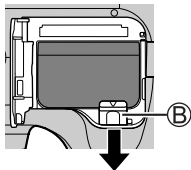

• To remove card

Push the card until it clicks, then pull the card out.

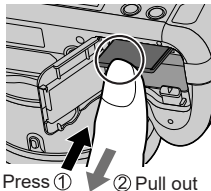

- Always use genuine Panasonic batteries (DMW-BMB9E).
- If you use other batteries, we cannot guarantee the quality of this product.
- Keep the Memory Card out of reach of children to prevent swallowing.

Charging the battery

Use an AC adaptor (optional/commercially available) and USB connection cable (commercially available) to charge the battery.

- For charging, we recommend using the AC adaptor (DMW-AC11: optional).
- The battery can be charged using a commercially available AC adaptor or USB connection cable.
 - Recommended specifications for AC adaptors (commercially available)
 - Supports DC 5 V / 3 A (15 W) output
 - USB Type-C
 - For charging, use a USB connection cable with an output of 15 W or higher.
- You can also use an AC adaptor of 5 V / 500 mA or higher for charging. However, charging time may be longer than the recommended AC adaptor.
- We do not guarantee operations with all commercially available devices.
- Charge the battery using this camera and the specified method. Using charging methods other than those specified may result in fluid leakage, overheating, combustion, rupturing, etc., and these may cause injury.

■ About the battery pack

The battery that can be used with this unit is DMW-BMB9E.

- This battery may present a risk of fire or chemical burn if mistreated.
- To ensure that safe products are used, we recommend that a genuine Panasonic battery pack is used. There is a possibility that other battery packs may lead to fire or explosion. Please be advised that we are not liable for any accident or failure occurring as a result of use of a counterfeit battery pack.

The battery is not charged at the time of purchase. Charge the battery before use.

We recommend charging in a location where the ambient temperature is between 10 °C and 30 °C (50 °F to 86 °F).

Insert the battery into the camera.
Make sure that the camera is turned off.

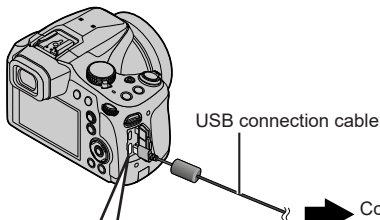

Connect to the AC adaptor or PC.
• Keep the computer turned on.

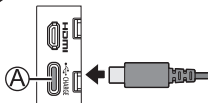

Ⓐ [USB/CHARGE] socket

• This terminal is located at the bottom when the camera is in an upright position.

• Check the direction of the terminals and plug in/out straight holding onto the plug. (Inserting these at an angle may cause deformation or malfunction)

- If the computer enters sleep mode during charging, charging may be stopped.
- If a notebook computer that is not connected to an electrical outlet is connected to the camera, the battery of the notebook computer will be depleted. Do not leave the camera and notebook connected for a long period of time.
- Always connect the USB connection cable to the USB connector on your computer. Do not connect the USB connection cable to the USB connector of the monitor, keyboard, printer, or USB hub.
- Even when the camera on/off switch is set to [OFF] thus turning the camera off, it consumes power.
When the camera will not be used for a long time, remove the power plug from the electrical outlet in order to save power.
- If the battery indication does not go to [■] even when charging is complete, the battery may be deteriorating. Try not to use that battery.

■ Charging lamp indications

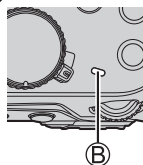
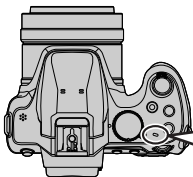

Ⓑ Charging lamp

On: Charging in progress

Off: Charging complete (After charging stops, disconnect the camera from the electrical outlet or your computer.)

Flashing: Charging error (→50)

■ Notes on charging time

Charging time

When using the AC adaptor (optional)	Approx. 180 min.
--------------------------------------	------------------

- The charging time indicated above is the time required for charging in case when the battery is completely used up. The time required for charging differs depending on conditions of battery usage. Charging takes longer in cases when temperatures are either high or low and when the battery has not been used for a long period of time.
- The time required for charging through the computer varies depending on the power supply capacity of the computer.

Setting the clock

The clock is not set when the camera is shipped.

1 Turn the camera on

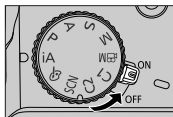

2 Press [MENU/SET]

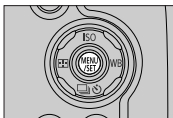

3 Press ▲ ▼ to select the language and press [MENU/SET]

- The [Please set the clock] message appears.

4 Press [MENU/SET]

5 Press ◀ ▶ to select the items (year, month, day, hour, minute), and press ▲ ▼ to set

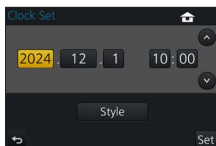

6 Press [MENU/SET]

7 When [The clock setting has been completed.] is displayed, press [MENU/SET]

8 When [Please set the home area] is displayed, press [MENU/SET]

9 Press ◀ ▶ to set your home area and press [MENU/SET]

- Time zones may be revised depending on the country or area, so the place name displayed on the screen may not match the actual time zone. Please also refer to the time difference displayed at the bottom of the screen before setting.

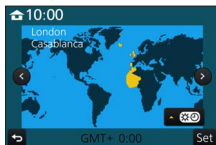

Basic operations

Zoom lever (Use zoom)

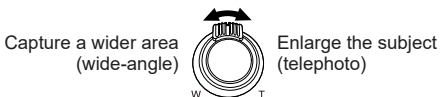

■ Zoom types and use

Optical Zoom:

You can zoom in without degrading the picture quality.

Maximum magnification: 60x

Extra optical zoom:

This function works when picture sizes with [EX] have been selected in [Picture Size]. Extra optical zoom allows you to zoom in using a higher zoom ratio than optical zoom, without degrading the picture quality.

Maximum magnification: 122x*

*Including the optical zoom ratio.

[i.Zoom]:

You can use the camera's intelligent resolution technology to increase the zoom ratio up to 2x higher than the original zoom ratio with limited deterioration of picture quality. (Up to 1.5x the original zoom ratio when [Picture Size] is set to [S])

[Digital Zoom]:

Zoom 4x further than Optical/Extra optical zoom. When [Digital Zoom] is used simultaneously with [i.Zoom], you can only increase the zoom ratio up to 2x. Note that, with Digital Zoom, enlarging will decrease picture quality.

- When [Live View Mode] (→44) is set to [ECO 30fps], Digital Zoom is not available (default setting).

■ [Zoom Compose Assist] button (Using the Zoom Compose Assist function)

If you lose the subject while zoomed in:

- ① Press and hold [] ([Zoom Compose Assist] button)

- A frame indicating the original zoom magnification (angle of view) will appear.

When you find the subject:

- ② Align the frame with the subject and release your finger from the button

Shutter button (Taking pictures)

1 Press the shutter button halfway (press lightly) to focus on the subject

- The aperture value and shutter speed are displayed. (If the aperture value and shutter speed are shown in red and flashing, you do not have the appropriate exposure, unless you are using the flash.)

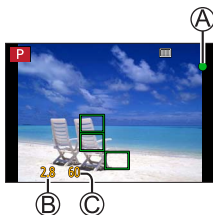

- (A) Focus display
(When focus is aligned: illuminated
When focus is not aligned: flashing)
- (B) Aperture value
- (C) Shutter speed

2 Press the shutter button fully (push the button all the way), and take the picture



- Pictures can be taken only when the image is correctly focused as long as the [Focus/Release Priority] (→44) is set to [FOCUS].

■ Estimated number of recordable pictures

1610*

- * (When [Aspect Ratio] is set to [4:3], [Quality] is set to [L], [Picture Size] is set to [L] (18M), and using a card of 16 GB)

■ Check the picture you have taken



- [Auto Review] displays the pictures you have taken after taking still pictures.
- Press the [] (Playback) button to display the picture. (→40)

Mode dial (Select the recording mode)

1 Set to the desired recording mode

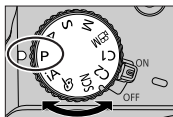
- Rotate the mode dial slowly to select the desired mode.



iA	iA Intelligent Auto Mode (→26)
	iA+ Intelligent Auto Plus Mode (→26)
P	Program AE Mode Take pictures with automatic shutter speed and aperture value settings.
A	Aperture-Priority AE Mode Determine aperture, then take pictures.
S	Shutter-Priority AE Mode Determine shutter speed, then take pictures.
M	Manual Exposure Mode Determine aperture and shutter speed, then take pictures.
 M	Creative Video Mode Determine aperture and shutter speed, then record motion pictures. • You cannot take still pictures.
C1/C2	Custom Mode Take pictures using pre-registered settings.
SCN	Scene Guide Mode Take pictures that match the scene being recorded.
	Creative Control Mode Take pictures by selecting your preferred picture effect.

[AF/AF $\text{\textcircled{A}}$ /MF] button (Switching the focus mode)

1 Press [AF/AF $\text{\textcircled{A}}$ /MF] button

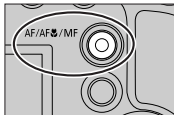

2 Press \blacktriangleleft \blacktriangleright to select the focus mode and press [MENU/SET]

- [AF]
 - Focus is set automatically when the shutter button is pressed halfway. To switch [AF Mode] (\rightarrow 23)
- [AF $\text{\textcircled{A}}$] ([AF Macro])
 - You can take pictures of a subject as close as 1 cm (0.033 feet) from the lens by rotating the zoom lever upmost to Wide.
- [AF $\text{\textcircled{M}}$] ([Macro Zoom])
 - Use this setting to get close to the subject and then further enlarge when taking the picture. You can take a picture with the digital zoom up to 3x while maintaining the distance to the subject for the extreme Wide position (1 cm (0.033 feet)).
- [MF] (\rightarrow 27)

[LVF] button (Switching the Monitor/Viewfinder)

1 Press [LVF] ($\text{\textcircled{A}}$) button

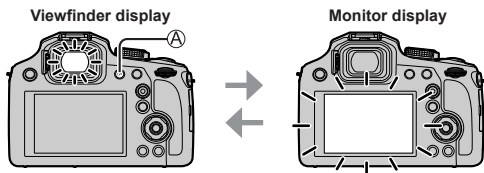

- If [Monitor Priority (Play)] of the [Setup] menu is set to [ON], pictures will be played back on the monitor after switching to playback mode.

■ About diopter adjustment

Rotate the diopter adjustment dial ($\text{\textcircled{B}}$) to adjust until you are able to clearly see the characters displayed in the viewfinder.

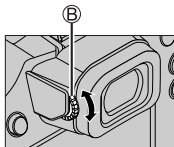

Rear dial

There are 2 ways to operate the rear dial, rotating left or right, and deciding by pressing.

Rotating:

Selection of items or setting of values is performed during the various settings.

Pressing:

Operations that are the same as [MENU/SET] button, such as determine settings, etc., are performed during the various settings.



- You can use the rear dial to compensate the exposure (→28) or adjust the aperture value and shutter speed. The items that can be adjusted differ according to the recording mode.

Cursor button

- Selection of items or setting of values etc., is performed.
- These operating instructions expresses the up, down, left, and right of the cursor button as ▲▼◀▶.

You can perform the following operations while recording. (Some items or settings cannot be selected depending on the mode or display style the camera is in.)

[ISO] (ISO sensitivity) (▲)

- Set ISO sensitivity (sensitivity to lighting). We recommend higher settings to take clear pictures in darker locations.

[WB] (White balance) (▶)

- Adjusts the colour depending on the light source to ensure natural colour.

[] (Drive mode) (▼)

- [] ([Burst])*
 - Records a burst of still pictures while you press the shutter button fully.
- [] ([4K PHOTO])* (→29)
- [] ([Post Focus])* (→32)
- [] ([Self Timer])*

* To cancel drive mode, select [] ([Single]) or [] ([Off]).

[] (AF Mode) (◀)

- This allows the focusing method that suits the positions and number of the subjects to be selected.

Function buttons

- [Fn1] to [Fn3] are buttons on the camera.
- [Fn4] to [Fn8] are touch icons. They are displayed by touching the [Fn] tab on the recording screen.
- You can assign frequently-used functions to particular buttons or icons with [Fn Button Set] in [Custom] menu.

Touch screen (Touch operations)

Touch screen of this unit is capacitive. Touch the panel directly with your bare finger.

Touch

To touch and release the touch screen. Be sure to touch the centre of the desired icon.



Drag

To touch and slide your finger across the touch screen. This can also be used to forward or rewind a picture during playback, etc.



Pinch (spread/pinch)

On the touch screen, spread (pinch out) your 2 fingers to zoom in, and pinch (pinch in) your 2 fingers to zoom out.



Setting the menu

- 1 Press [MENU/SET] to bring up the menu
- 2 Press ▲▼ to select the menu item and press [MENU/SET]
- 3 Press ▲▼ to select the setting and press [MENU/SET]

- The setting methods vary depending on the menu item.



- 4 Press [Q.MENU/↵] button repeatedly until the recording or playback screen reappears

- During recording, the menu screen can also be exited by pressing the shutter button halfway.

■ Switching menu type

- ① Press ◀ after performing step 1 above
- ② Press ▲▼ to select a tab such as [wrench]
- ③ Press [MENU/SET]





■ Menu types (→43)

- [Rec]
- [Motion Picture]
- [Setup]
- [Custom]
- [Playback]



Taking pictures with automatic settings

(Intelligent Auto Mode)

Recording mode:  

This mode is recommended for those who want to point and shoot as the camera optimises settings to match the subject and recording environment.

1 Set mode dial to [iA]

- The camera will switch to either the most recently used of Intelligent Auto Plus Mode  or Intelligent Auto Mode .

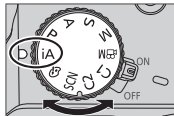



2 Point the camera at the subject



- When the camera identifies the optimal scene, the icon for each scene turns blue for 2 seconds and then changes to the normal red indication.





■ Switching between Intelligent Auto Plus Mode and Intelligent Auto Mode



- Touch the recording mode icon at the upper left in recording screen
- Select  or  and touch [Set]



-  allows you to adjust some settings such as the brightness and colour tone while also using  for other settings so that you can record pictures more suited to your preferences.

■ Auto Focus (Face/Eye Detection)

[AF Mode] is automatically set to . If you touch the subject, the camera switches to  and the AF tracking function starts operating.

You can also switch to  by pressing . Align the AF tracking area with the subject and press the shutter button halfway to operate the AF tracking function.

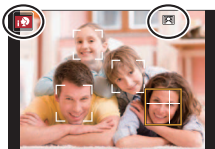

Taking pictures with Manual Focus

Recording mode: **[IA] [AF] [P] [A] [S] [M] [M] [SCN]**

Manual Focus is convenient when you want to lock the focus to take pictures or when it is difficult to adjust focus using Auto Focus.

1 Press [AF/AF-LOCK/MF] button

2 Press ◀▶ to select [MF] and press [MENU/SET]

3 Press [MF Assist] button (◀)

- The focus adjusting screen will be displayed.
- When [MF Assist] is set to [ON], MF Assist (enlarged screen) is displayed (→44). You can move the enlarged part by dragging the screen (→24).

4 Adjust the focus

- (A) MF Assist (Enlarged screen)
- (B) MF Guide
- (C) Peaking
- (D) Slide bar

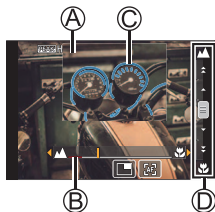

▶	Focuses on nearby subject
◀	Focuses on distant subjects

- Pressing and holding ◀▶ will increase the focus speed.
- Focus can also be adjusted by dragging the slide bar.
- Colour is added to the portions of the image that are in focus. (Peaking)

Operation	Touch operation	Description
—	Pinch in / Pinch out	Enlarges/reduces the screen in small steps.
	—	Enlarges/reduces the screen in large steps.
		Switches the enlarged display. (windowed/full screen)

* This setting is not available in Intelligent Auto Mode.

5 Press the shutter button halfway

- The recording screen will be displayed.

Taking pictures with Exposure Compensation

Recording mode: **IA** **IA** **P** **A** **S** **M** **SCN**

Corrects the exposure when there is a backlight or when the subject is too dark or too bright.

1 Press the rear dial to switch to Exposure Compensation operation

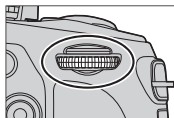

2 Rotate the rear dial to compensate the exposure

- (A) Exposure Bracket
- (B) Exposure Compensation

Operation	Description
	Compensates the exposure
	Sets the exposure bracket (→35)

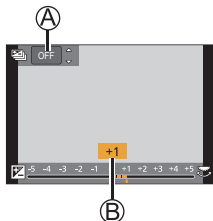

3 Press the rear dial to set

- You can also press the shutter button halfway to set.

- You can set the exposure compensation value in the range between -5 EV and $+5$ EV.
Settings can be made within a range of -3 EV to $+3$ EV while recording motion pictures, recording 4K photos, or recording in [Post Focus].
- Depending on the brightness, this may not be possible in some cases.

Recording with the 4K Photo function





Recording mode: **[A]** **[P]** **[AS]** **[M]** **[SCN]** **[C]**

You can take burst pictures of approximately 8 million pixels with a burst rate of 30 fps. You can select and save a frame from the burst file.

- To record pictures, use a UHS Speed Class 3 card.
- When recording, the angle of view becomes narrower.

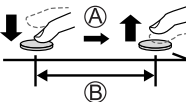
1 Press **[4K]** button

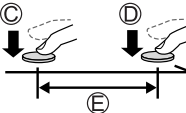
2 Press **◀▶** to select the recording method and press **[MENU/SET]**

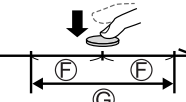



 [4K Burst]	<p>For capturing the best shot of a fast-moving subject Burst recording is performed while the shutter button is pressed and held.</p> <ul style="list-style-type: none"> • Recording will start approximately 0.5 seconds after you press the shutter button fully. Therefore, press the button fully as soon as possible. <p>(A) Press and hold (B) Recording is performed</p>	
 [4K Burst(S/S)] "S/S" is an abbreviation of "Start/Stop".	<p>For capturing unpredictable photo opportunities Burst recording starts when the shutter button is pressed and stops when pressed again.</p> <p>(C) Start (First) (D) Stop (Second) (E) Recording is performed</p>	
 [4K Pre-Burst]	<p>For recording as needed whenever a photo opportunity arises Burst recording is performed for approximately 1 second before and after the moment that the shutter button is pressed.</p> <p>(F) Approximately 1 second (G) Recording is performed</p>	

3 Record a 4K photo

- When you perform 4K burst photo recording, a 4K burst file will be saved in the MP4 format.
- When [Auto Review] is enabled, the picture selection screen will be displayed automatically.
- You can compare multiple frames captured in a 4K burst file, overlay the bright areas, and combine them into one picture. ([Light Composition]) (→41)

■ To cancel the 4K Photo functions

In step 2, select [].

- If the surrounding temperature is high or 4K photos are recorded continuously, [] may be displayed and recording may be stopped halfway through. Wait until the camera cools down.
- **When [] ([4K Pre-Burst]) is set, the battery drains faster and the camera temperature rises. (to protect itself, the camera may switch to [] ([4K Burst]))**
Select [] ([4K Pre-Burst]) only when recording.
- Recording stops when the continuous recording time exceeds 15 minutes. When using an SDHC memory card, files are split into smaller picture files for recording and playback if the file size exceeds 4 GB. (You can continue to record pictures without interruption.)
 If using an SDXC Memory Card, you can record pictures in a single file even if the size is greater than 4 GB.

Selecting pictures from 4K burst file and saving

- 1 Select a picture with the [▲] [▶] [◀] [▼] on the playback screen, and press ▲
 - In the case of recording with [4K PRE] ([4K Pre-Burst]), proceed to the step 3.
- 2 Drag the slide bar to perform rough scene selection



- 3 Drag to select the frame you want to save as a picture
 - Touch [◀] / [▶] to display the previous or next set of frames (45) in slide view.



- 4 Touch [▶] to save the picture
 - The picture will be saved in JPEG format.

- For details, refer to “Operating Instructions for advanced features (PDF format)”.

[4K PHOTO Bulk Saving]

If you use [4K PHOTO Bulk Saving] in the [Playback] menu, you can bulk save 5 seconds' worth of 4K recording.

- 1 Use ◀▶ to select the 4K burst files and press [MENU/SET]
 - If the burst time is 5 seconds or less, all the frames can be saved as a picture.
- 2 Select the first frame to be bulk saved as a picture
 - The selection method is the same as the operation to choose the frame you want to save as a picture from a 4K burst file. (above)
 - The picture will be saved in JPEG format as a single burst picture group.

Adjusting the focus after recording

([Post Focus] / [Focus Stacking])

Recording mode: **P** **A** **S** **M** **SCN**

You can record 4K burst pictures while changing the focus point and then select a focus point after recording. This function is best for non-moving subjects.

You can select multiple focus points and combine them into one picture. ([Focus Stacking])

- We recommend using a tripod to perform [Focus Stacking].
- To record pictures, use a UHS Speed Class 3 card.
- During recording, the angle of view will be narrower.

1 Touch

2 After touching , touch [ON]

- You can also set it to [ON] by pressing the button () , using to select a [Post Focus] icon ().

3 Determine the composition and press the shutter button halfway

- Auto Focus activates and automatically detects the focus point on the screen.
- If there is no focus point on the screen, the Focus indicator () blinks and you cannot record.



From halfway pressing the shutter button to completion of recording

- Do not change the distance to subject or the composition.

4 Press the shutter button fully to start recording

- The focus point changes automatically while recording. When the recording progress bar () disappears, recording automatically ends.
- A motion picture will be recorded in MP4 format. (No audio is recorded.)
- If Auto Review is set, a screen will automatically appear that lets you select the focus point. (→33)



■ Cancelling [Post Focus]

Touch and select [OFF] in step 2.

- The operation can be cancelled by pressing the button () and then selecting ([Single]) or ([OFF]).
- If the surrounding temperature is high or [Post Focus] recording is performed continuously, may be displayed and recording may be stopped halfway through. Wait until the camera cools down.

Select the focus point and save the picture ([Post Focus])













1 On the playback screen, select the image with the  icon and press **▲**



2 Touch the focus point

- If there are no pictures with the focus on the selected point, a red frame will be displayed, and pictures cannot be saved.
- The edge of the screen cannot be selected.



Operation		Touch operation	Description
		Touch	Select focus point • No selection can be made while display is enlarged.
		 / 	Enlarge display / Shrink display (when in enlarged display)
[Fn1]			Switches to [Focus Stacking] operation (→34)
[Fn2]			In-focus portions are highlighted with colour. ([Peaking]) • Switches in order of [PEAK OFF] → [PEAK L] ([LOW]) → [PEAK H] ([HIGH]).
[MENU/SET]			Save picture

- You can make fine adjustments to the focus by dragging the slide bar during enlarged display.

3 Touch  to save the picture

- The picture will be saved in JPEG format.

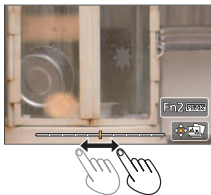

- You cannot choose and save the picture from a TV screen even if the camera is connected to a TV through an HDMI micro cable.

Select the focus range to combine and create a single picture ([Focus Stacking])

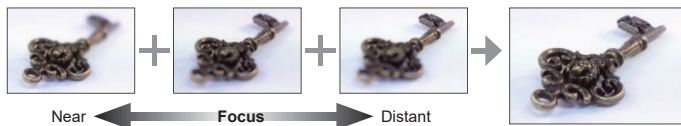

- 1 Touch on screen in step 2 of “Select the focus point and save the picture ([Post Focus])” (→33)
- 2 Choose a stacking method and touch it

[Auto Merging]	Automatically select photos suitable for stacking and combine them into one picture. <ul style="list-style-type: none"> • Choose by giving preference to near-focus pictures. • Perform the focus stacking and save the picture.
[Range Merging]	Combine the pictures with the selected focus position into one picture.

- 3 (When selecting [Range Merging])
Touch the focus point

- Select positions at two or more points.
- Focus points between the selected two positions will be selected.
- Positions that cannot be selected, or that would produce an unnatural result will be greyed out.

- Touch a position again to deselect it.

- 4 Touch to combine and save the picture

- The picture will be saved in JPEG format.

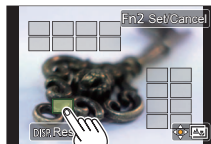

- Only pictures taken using [Post Focus] are eligible for [Focus Stacking].

Taking Pictures While Adjusting a Setting Automatically (Bracket Recording)

Recording mode: **PAS**

You can take multiple pictures while automatically adjusting a setting by pressing the shutter button.

1 Set the menu (→25)

MENU → [Rec] → [Bracket] → [Bracket Type]	
(Exposure Bracket)	Press the shutter button to perform recording while adjusting the exposure.
(White Balance Bracket)	Press the shutter button once to take three pictures with different white balance settings automatically.

2 Press ▼ to select [More Settings] and then press [MENU/SET]

- If [] is set, rotate the rear dial to set the adjustment range.
- Press the shutter button halfway to exit the menu.

3 Focus on the subject and take a picture

■ To cancel [Bracket]

Select [OFF] in step 1.

Exposure Bracket

■ About [More Settings] (step 2 above)

[Step]	Sets the number of pictures to be taken and the exposure compensation range.
[Sequence]	Sets the order in which pictures are taken.
[Single Shot Setting]*	: Takes one picture each time you press the shutter button. : Takes all the pictures set to be taken when you press the shutter button once.

* Not available for burst recording.

Recording Motion Picture/4K Motion Picture

Recording mode: **IA** **IA** **P** **A** **S** **M** **M** **SCN** 

You can record full high-definition quality images that comply with the AVCHD standard, as well as motion pictures or 4K motion pictures recorded in MP4.

1 Press the motion picture button to start recording

- (A) Recording (flashes red)
- (B) Elapsed recording time
- (C) Remaining recording time

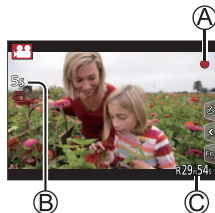

- Recording of motion picture appropriate for each motion picture mode is possible.
- Immediately release the motion picture button after pressing it.
- If you press the shutter button down fully, you can take still pictures while recording motion pictures. (Except for in Creative Video Mode)

2 Press the motion picture button again to end recording

- If the surrounding temperature is high, or a motion picture is recorded continuously, [] is displayed and recording may be stopped halfway through. Wait until the camera cools down.
- **With recording in a quiet environment, the sound of aperture, focus and other actions may be recorded in motion pictures. This is not a malfunction.**
- To record 4K motion pictures, use a UHS Speed Class 3 card.
- When you record 4K motion pictures, the angle of view will be narrower than motion pictures of other sizes.
- To ensure highly accurate focus, 4K motion pictures are recorded at reduced Auto Focus speeds. It may be difficult to focus on the subject with Auto Focus, but this is not a malfunction.

■ Setting the format, picture size and recording frame rate

MENU →  **[Motion Picture]** → **[Rec Format]**

Settings: **[AVCHD]** / **[MP4]**

MENU →  **[Motion Picture]** → **[Rec Quality]**

When **[AVCHD]** is selected:

[FHD/28M/50p]*1 / **[FHD/17M/50i]** / **[FHD/24M/25p]**

● **[AVCHD]** motion pictures:

Files are split into smaller motion picture files for recording when the file size exceeds 4 GB.

● Motion pictures with **[Rec Quality]** setting of **[FHD/28M/50p]/[FHD/17M/50i]** in **[AVCHD]**:

Recording stops when the continuous recording time exceeds 29 minutes and 59 seconds.

When **[MP4]** is selected:

[4K/100M/30p]*2 / **[4K/100M/25p]*2** / **[FHD/28M/60p]** / **[FHD/28M/50p]** /

[FHD/20M/30p] / **[FHD/20M/25p]** / **[HD/10M/30p]** / **[HD/10M/25p]**

● Motion pictures with their file size set to **[FHD]** or **[HD]** in **[MP4]**:

Files are split into smaller motion picture files for recording and playback when the file size exceeds 4 GB. (You can continue to record motion pictures without interruption.)

● Motion pictures with **[Rec Quality]** setting of **[FHD/28M/60p]/[FHD/28M/50p]** in **[MP4]**:

Recording stops when the continuous recording time exceeds 29 minutes and 59 seconds.

● Motion pictures with their file size set to **[4K]** in **[MP4]**:

Recording stops when the continuous recording time exceeds 15 minutes.

When using an SDHC memory card, files are split into smaller motion picture files for recording and playback if the file size exceeds 4 GB. (You can continue to record motion pictures without interruption.)

If using an SDXC Memory Card, you can record a motion picture in a single file even if the size is greater than 4 GB.

*1 AVCHD Progressive

*2 4K motion pictures

[4K Live Cropping]

Recording mode: 

By cropping your motion picture down from the 4K angle of view to Full High Definition, you can record a motion picture that pans and zooms in/out while leaving the camera in a fixed position.

- Hold the camera firmly in place while recording.
- A motion picture will be recorded at [FHD/20M/25p] under [MP4].



Pan



Zoom in

- When you want to zoom in/out, set different angles of view for the cropping start and end frames. For example, to zoom in, set a larger angle of view for the start frame and a smaller angle of view for the end frame.

1 Set mode dial to

2 Set the menu (→25)

MENU →  [Motion Picture] → [4K Live Cropping]

Settings: [40SEC] / [20SEC] / [OFF]

- The angle of view narrows.

3 Set the crop start frame

- When making settings for the first time, a crop start frame of size 1920×1080 is displayed. (After setting the crop start frame and end frame, the start frame and end frame that you set immediately before will be displayed.)

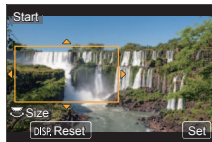

Operation	Touch operation	Description
	Touch	Moves the frame
	Pinch out / Pinch in	Enlarges/reduces the frame (The range of settings allowed is from 1920×1080 to 3840×2160.)
[DISP.]	[Reset]	Returns the position of the frame to the centre and its size to the default setting.
[MENU/SET]	[Set]	Decides the position and size of the frame

4 Repeat step 3, and then set the crop end frame



5 Press the motion picture button (or the shutter button) to start recording

- (A) Elapsed recording time
- (B) Set operating time

- Immediately release the motion picture button (or the shutter button) after pressing it.
- When the set operating time has elapsed, recording automatically ends. To end recording midway, press the motion picture button (or the shutter button) again.

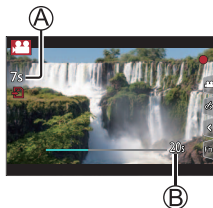

■ Changing the position and size of a crop frame

Press [Fn1] button while the recording screen is displayed, and perform steps 3 and 4.

■ To cancel [4K Live Cropping] recording

Set [OFF] in step 2.

- Focus is adjusted and fixed in the crop start frame.
- [Continuous AF] is set to [OFF].
- [Metering Mode] will be [] (Multi Metering).

Viewing your pictures

1 Press [▶] (Playback) button

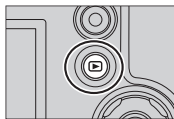

2 Press ◀▶ to select a picture to be displayed

- The playback screen appears if the camera is turned on while pressing [▶] (Playback) button.
- When [Lens Retraction] (→44) is set to [ON], the lens barrel is retracted after approx. 15 seconds as the camera is switched to the playback screen from the recording screen.

■ Viewing motion pictures

This unit was designed to play motion pictures using the AVCHD and MP4 formats.

- Motion pictures are displayed with the motion picture icon ([▶]).

① Press ▲ to start playback

- If you press [MENU/SET] during a pause, you can create a picture from a motion picture.



■ Deleting pictures

Deleted pictures cannot be recovered.

- ① Press [⏏] button to delete displayed picture
- ② Use ▲ to select [Delete Single] and press [MENU/SET]

■ Ending Playback

Press [▶] (Playback) button again or press the motion picture button.
The playback can also be ended by pressing the shutter button halfway.

[Light Composition]

Select multiple frames from 4K burst files that you wish to combine. Parts of the image that are brighter than the preceding frame will be superimposed on the preceding frame to combine the frames into one picture.



- When using [Light Composition], we recommend using a tripod and self-timer for taking pictures to prevent camera shake.

MENU → **▶** [**Playback**] → [**Light Composition**]

1 Use ◀▶ to select the 4K burst files and press [MENU/SET]

2 Choose the combining method and press [MENU/SET]

■ [Composite Merging]: Selecting frames to combine

- ① Drag the slide bar or use ▲▼◀▶ to select the frames to combine
- ② Press [MENU/SET]
 - The selected frames are remembered, and the display goes to the preview screen.
 - Use ▲▼ to select items and press [MENU/SET] to perform the following operations.

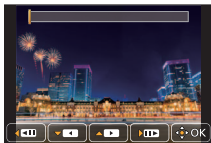

- [Next]: Lets you select more frames for combining.
 - [Reselect]: Discards the frame selected immediately before and lets you select a different image.
- ③ Repeat steps ① - ② to select more frames to combine (up to 40 frames)
 - ④ Press ▼ to select [Save] and press [MENU/SET]

■ **[Range Merging]: Selecting a range to combine**

- ① Select the frame of the first picture and then press [MENU/SET]
 - The selection method is the same as in step ① of [Composite Merging] setting. (→41)
- ② Select the frame of the last picture and then press [MENU/SET]

3 Select [Yes] at the confirmation screen and press [MENU/SET]

- The picture will be saved in JPEG format.

Menu list

- The [Photo Style], [Filter Settings], [AFS/AFF/AFC], [Metering Mode], [Highlight Shadow], [i.Dynamic], [i.Resolution], [Diffraction Compensation], [i.Zoom], [Digital Zoom], [Stabilizer], and [Conversion] menu items are common for both [Rec] and [Motion Picture] menus. If a setting in one menu is changed, the setting with the same name in other menu will also be changed automatically.

■ To display explanations of the menu items

When [Menu Information] in the [Setup] menu is set to [ON], explanations of the menu items and settings are displayed on the menu screen.

Ⓐ Explanations of the menu items and settings

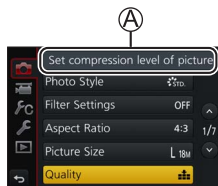

📷 [Rec]

[Photo Style]	[i.Dynamic]	[Extended ISO]
[Filter Settings]	[i.Resolution]	[Diffraction Compensation]
[Aspect Ratio]	[iHandheld Night Shot]	[i.Zoom]
[Picture Size]	[iHDR]	[Digital Zoom]
[Quality]	[HDR]	[Conversion]
[AFS/AFF/AFC]	[Multi Exp.]	[Color Space]
[Metering Mode]	[Time Lapse Shot]	[Stabilizer]
[Burst Rate]	[Stop Motion Animation]	[Face Recog.]
[4K PHOTO]	[Shutter Type]	[Profile Setup]
[Bracket]	[Flash]	
[Self Timer]	[ISO Limit Set]	
[Highlight Shadow]	[ISO Increments]	

🎬 [Motion Picture]

[4K Live Cropping]	[Exposure Mode]	[Silent Operation]
[Snap Movie]	[High Speed Video]	[Wind Noise Canceller]
[Rec Format]	[Continuous AF]	[Zoom Mic]
[Rec Quality]	[Flkr Decrease]	

fC [Custom]

[Cust.Set Mem.]	[MF Assist Display]	[Monitor Info. Disp.]
[Silent Mode]	[MF Guide]	[Rec Area]
[AF/AE Lock]	[Peaking]	[Remaining Disp.]
[AF/AE Lock Hold]	[Histogram]	[Auto Review]
[Shutter AF]	[Guide Line]	[Fn Button Set]
[Half Press Release]	[Center Marker]	[Zoom lever]
[Quick AF]	[Highlight]	[Zoom Compose Assist]
[Pinpoint AF Time]	[Zebra Pattern]	[Lens Position Resume]
[Pinpoint AF Display]	[Monochrome Live View]	[Lens Retraction]
[AF Assist Lamp]	[Constant Preview]	[Q.MENU]
[Direct Focus Area]	[Expo.Meter]	[Video Button]
[Focus/Release Priority]	[Dial Guide]	[Touch Settings]
[AF+MF]	[LVF Disp.Style]	[Touch Scroll]
[MF Assist]	[Monitor Disp. Style]	[Menu Guide]

f [Setup]

[Clock Set]	[Power Save Mode]	[No.Reset]
[World Time]	[TV Connection]	[Reset]
[Travel Date]	[Menu Resume]	[Format]
[Beep]	[Menu Background]	
[Live View Mode]	[Menu Information]	
[Monitor Display]/ [Viewfinder]	[Language]	
[Monitor Luminance]	[Version Disp.]	
[Monitor Priority (Play)]	[Exposure Comp. Reset]	
	[Self Timer Auto Off]	

▶ [Playback]

[Slide Show]	[Text Stamp]	[Rotate Disp.]
[Playback Mode]	[Video Divide]	[Favorite]
[RAW Processing]	[Time Lapse Video]	[Protect]
[4K PHOTO Bulk Saving]	[Stop Motion Video]	[Face Rec Edit]
[Light Composition]	[Resize]	[Picture Sort]
[Clear Retouch]	[Cropping]	
[Title Edit]	[Rotate]	

Downloading software

Still/motion pictures can be copied from the camera to your computer by connecting the two together. If you wish to play back or edit pictures on a PC, download software from the supplier's website and install it on your PC.

- To download the software, your PC must be connected to the Internet.
- It may take time to download the software in some communication environments.

PHOTOfunSTUDIO 10.0 AE

You can capture still pictures or motion pictures to your PC, or organise captured pictures by categorising by recording date, model name of the digital camera used to record, etc. You can also correct still pictures, edit motion pictures, or write to DVD.

- Check the website below to download/install the software.
https://panasonic.jp/support/global/cs/soft/download/d_pfs10ae.html
 (English only)
 Download expiration: January 2030
- Supported OS: Windows® 8.1 / 10 / 11
 - “PHOTOfunSTUDIO” is not compatible with Mac.
 - For details, refer to “Operating Instructions for advanced features (PDF format)”.

SILKYPIX Developer Studio SE

This software develops and edits RAW file pictures. Edited pictures can be saved in a file format such as JPEG or TIFF that can be displayed on a PC, etc.







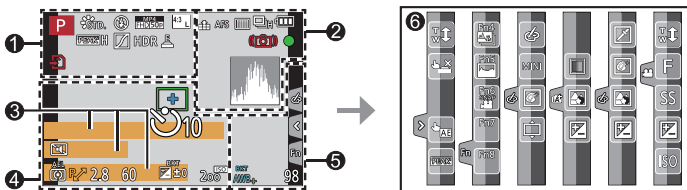

- Check the website below to download/install the software.
<http://www.isl.co.jp/SILKYPIX/english/p/>
- Supported OS: Windows® 10 / 11
 macOS 10.13 to 10.15, 11, 12, 13, 14
- For details on the operating environment and how to use the SILKYPIX Developer Studio, refer to the “Help” or the Adwaa’s support website.







List of monitor/viewfinder displays

- The following images are examples of when the display screen is set to  (monitor style) in the monitor.















In recording



1	 P	Recording mode (→21)
	 C1	Custom Set
	 STD.	[Photo Style]
	 ⓧ	[Flash]
	 MP4 FHD150p	[Rec Format]/ [Rec Quality]
	 SNAP 4SEC	[Snap Movie]
	 4:3 L	[Aspect Ratio]/ [Picture Size]
	 +	Picture effect (Filter) adjustment display
	EXPS	Types of picture effects (Filter)
		Card (displayed only during recording)

XXmXXs	Elapsed recording time
	Simultaneous recording indicator (When taking still pictures while recording a motion picture)
PEAK H	[Peaking]
	[Highlight Shadow]
HDR	[HDR]/[iHDR]
	[Multi Exp.]
	[Conversion]
	Electronic shutter
	Overheat indicator (→30, 32, 36)











②

	[Quality]
200fps 100fps	[High Speed Video]
AFS	[AFS/AFF/AFC]/MF
	AF Mode
	[Pull Focus]
	[Face Recog.]
AFL	AF Lock
	Burst
	[4K PHOTO] (→29)
	[Post Focus] (→32)
	[Self Timer]
	Remaining battery
AF 	Macro recording (→22)
	[Stabilizer]
	Jitter alert
	Recording state (Flashes red.) (→36)/ Focus (Lights green.) (→20)
	Focus (Under low illumination)
	Histogram

③

Name*1
Travel elapsed days*2
Age in years/months*1
Location*2
Current date/time*2
Travel destination setting*2: 
Exposure meter
Zoom (→19)

④

	AF area
+	Spot metering target
+	[Center Marker]
	[Self Timer]
	[Zoom Mic]
	[Silent Mode]
AEL	AE Lock
	[Metering Mode]
	Programme Shift
2.8	Aperture value
60	Shutter speed
	Exposure compensation (→28)
	Exposure Bracket (→35)
	Brightness (exposure)
	Manual Exposure Assist
200 ^{ISO}	ISO sensitivity

5

	[Dial Guide]
BKT AWB+	White Balance Bracket (→35)
	White Balance Fine Adjustment
	White Balance
	Colouring
98	Number of recordable pictures
RXXmXXs	Available recording time

6

Touch tab

	Touch zoom
	Touch Shutter
	[Touch AE]
	[Peaking]
	Function buttons (→24)

	Colouring
	Defocus control function
	Brightness (exposure)
	Type of defocus ([Miniature Effect])
	[One Point Color]
	[Sunshine]
	Picture effect (Filter) adjustment display
	Picture effects ON or OFF
	Picture effects (Filter)
	F Aperture value
	SS Shutter speed
	ISO ISO sensitivity

*1 This is displayed for about 5 seconds when the camera is turned on if the [Profile Setup] (→43) setting is set.

*2 This is displayed for about 5 seconds when the camera is turned on, after setting the clock and after switching from Playback Mode to Recording mode.

- The information displayed, such as histograms, magnifications, and numeric values, are only for the purpose of reference.

■ On-monitor recording information

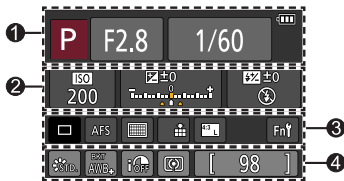

1	P	Recording mode (→21)		Single
	F2.8	Aperture value		Burst
	1/60	Shutter speed		[4K PHOTO] (→29)
		Remaining battery		[Self Timer]
2		ISO sensitivity	AFS	[AFS/AFF/AFC]/MF
	200	ISO sensitivity		AF Mode
		Exposure compensation (→28)		[Quality]
		Exposure Bracket (→35)		[Aspect Ratio]/ [Picture Size]
		Brightness (exposure)	Fn	Function button setting (→24)
		Manual Exposure Assist		
		[Flash]	4	
				[Photo Style]
			BKT	White Balance Bracket (→35)
			AWB+	White Balance Fine Adjustment
			AWB	White Balance
			iOFF	[i.Dynamic]
				[Metering Mode]
			98	Number of recordable pictures
			RXXmXXs	Available recording time

Q&A Troubleshooting

- Performing [Reset] in the [Setup] menu may resolve the issue.
- Further information is provided in the “Operating Instructions for advanced features (PDF format)”. Check it together with the information in this section.

The charging lamp blinks.

- Charging is being performed in a place with extremely high or low temperature.
→ **Reconnect the USB connection cable and retry charging in a place where ambient temperature is 10 °C to 30 °C (50 °F to 86 °F) (temperature conditions also apply to the battery itself).**
- Charging is not possible if the power supply capacity of the computer is low.

The battery runs down quickly.

- [4K PHOTO] is set to [Pre-Burst] ([4K Pre-Burst]).
→ When [Pre-Burst] ([4K Pre-Burst]) has been selected, the battery drains faster.
Select [Pre-Burst] ([4K Pre-Burst]) only when recording.

Focus not aligned correctly.

- Subject outside of focus range.
- [Focus/Release Priority] is set to [RELEASE]. (→44)
- [Shutter AF] is set to [OFF]. (→44)
- AF Lock is set inappropriately.
- If there are fingerprints or dirt on the lens, the focus may be set to the lens and not the subject.

Subject appears skewed in pictures.

- If you take a picture of a moving subject in the electronic shutter mode, motion picture recording mode, or 4K photo recording mode, the subject in the picture may be skewed in some cases. This is characteristic of MOS sensors which serve as the camera's pickup sensors. This is not a malfunction.

Striping or flicker may appear under lighting such as fluorescent lighting and LED lighting fixture.

- This is characteristic of MOS sensors which serve as the camera's pickup sensors. This is not a malfunction.
- If you are taking still pictures using the electronic shutter, the striping may be reduced by setting a slower shutter speed.
- When noticeable flicker or striping is seen under lighting such as a fluorescent or LED lighting fixture in the motion picture recording mode, you can reduce the flicker or striping by setting up [Flkr Decrease] (→43) and fixing the shutter speed. It is possible to select a shutter speed from [1/50], [1/60], [1/100], or [1/120]. You can set the shutter speed manually in the Creative Video Mode. (→21)

4K photo recording stops before finishing.

- When the ambient temperature is high or recording of the 4K Photo function is performed continuously, the camera may display [] and stop the recording. Wait until the camera cools down.

Cannot record motion pictures.

- When a large capacity card is used, you may not be able to take a picture for a while after you turn on the camera.

Sometimes focus adjustment with auto focus mode is difficult while recording 4K motion pictures.

- This may occur when taking a picture by reducing the auto focus speed in order to adjust the focus at high precision. This is not a malfunction.

No flash emitted.

- The flash becomes unavailable in the following cases.
 - The flash is closed.
- Set [Shutter Type] to [AUTO] or [MSHTR]. (→43)
- Set [Silent Mode] to [OFF]. (→44)

The lens makes a clicking noise.

- When the camera is turned on or off, the lens is moved, or an aperture operation is performed, such a noise may be heard. This is not a malfunction.
- When the brightness changes after a zooming operation or moving the camera, the lens may make a noise while adjusting the aperture. This is not a malfunction.

Zooming stops instantaneously.

- When using the Extra Optical Zoom, the zooming action will stop temporarily. This is not a malfunction.

Specifications

Digital Camera: Information for your safety

Power Source	7.2 V===
Power	2.0 W (When recording with monitor)
Consumption	2.8 W (When recording with viewfinder)
	1.6 W (When playing back with monitor)
	1.7 W (When playing back with viewfinder)

Camera effective pixels	18,100,000 pixels
Image sensor	1/2.3" MOS sensor, total pixel number 18,900,000 pixels Primary colour filter
Lens	Optical 60x zoom f=3.58 mm to 215 mm (35 mm film camera equivalent: 20 mm to 1,200 mm) Max. Wide: F2.8 to F8.0 Max. Tele: F5.9 to F8.0
Image Stabiliser	Optical method
Focus range	AF: 30 cm (0.98 feet) (Max. Wide)/ 1.5 m (4.9 feet) (Max. Tele) to ∞ AF Macro/MF/Intelligent Auto/Motion picture: 1 cm (0.033 feet) (Max. Wide)/ 1.5 m (4.9 feet) (Max. Tele) to ∞
Shutter system	Electronic shutter + Mechanical shutter
Minimum Illumination	Approx. 9 lx (when i-Low light is used, the shutter speed is 1/25th of a second)

Shutter speed	<p>Still picture: 60 seconds to 1/2000th of a second (When the mechanical shutter is used and [Artistic Nightscape] is selected as the Scene Guide Mode), 4 seconds to 1/2000th of a second (When the mechanical shutter is used, in cases other than the above), 1 second to 1/16000th of a second (When the electronic shutter is used)</p> <p>Motion picture: 1/2 second to 1/16000th of a second (When [Exposure Mode] is set to [M] in Creative Video Mode and [MF] is selected), 1/25th of a second to 1/16000th of a second (Other than the above)</p>
Exposure (AE)	Programme AE (P)/Aperture-priority AE (A)/Shutter-priority AE (S)/Manual exposure (M)/AUTO Exposure Compensation (1/3 EV steps, -5 EV to +5 EV)
[Metering Mode]	Multiple/Centre weighted/Spot
Monitor	3.0" TFT LCD (3:2) (Approx. 1,840,000 dots) (field of view ratio about 100%) Touch screen
Viewfinder	Aspect ratio 4:3, 0.39 inches, approx. 2,360,000 dots, organic EL (OLED) live view viewfinder (field of view ratio about 100%) [Magnification approx. 0.74x (35 mm film camera equivalent), -1.0 m ⁻¹ 50 mm at infinity, with aspect ratio set to [4:3]] (with diopter adjustment -4.0 to +4.0 diopter)
Flash	Built-in pop up flash AUTO, AUTO/Red-Eye Reduction, Forced ON, Forced ON/Red-Eye Reduction, Slow Sync., Slow Sync./Red-Eye Reduction, Forced OFF
Microphones	Stereo
Speaker	Monaural

Recording media	SD Memory Card/SDHC Memory Card*/ SDXC Memory Card* * UHS-I UHS Speed Class 3
Recording file format	
Still picture	RAW/JPEG (based on Design rule for Camera File system, based on Exif 2.3 standard)
Motion picture	AVCHD Progressive/AVCHD/MP4
Audio compression format	AVCHD: Dolby Audio™ (2 ch) MP4: AAC (2 ch)
Interface	
[HDMI]	Micro HDMI Type D
[USB/CHARGE]	USB 2.0 (High Speed) USB Type-C®
Dimensions	Approx. 130.2 mm (W) x 94.3 mm (H) x 125.2 mm (D) [5.13" (W) x 3.71" (H) x 4.93" (D)] (excluding the projection part)
Mass	With card and battery: Approx. 640 g (1.41 lb) Excluding card and battery: Approx. 596 g (1.31 lb)
Operating temperature	0 °C to 40 °C (32 °F to 104 °F)
Operating humidity	10%RH to 80%RH

■ Battery pack (lithium-ion)

(Panasonic DMW-BMB9E): Information for your safety

Voltage/capacity:	7.2 V/895 mAh
--------------------------	---------------

The symbols on this product (including the accessories) represent the following:

 DC

Specifications are subject to change without notice.

Digital Camera Accessory System

Description	Accessory#
Battery pack	DMW-BMB9
AC adaptor*1	DMW-AC11
Lens adaptor	DMW-LA8
Tele conversion lens*2	DMW-LT55
Flash	DMW-FL200L / DMW-FL580L
LED video light	VW-LED1

*1 Supplied with an AC mains lead and a USB connection cable.

*2 The lens adaptor (DMW-LA8: optional) is necessary to attach a tele conversion lens.

- Product numbers correct as of June 2024. These may be subject to change.
- Some optional accessories may not be available in some countries.

For the United Kingdom and Ireland customers (Sales and Support Information)

Customer Communications Centre

- For customers within the UK: 0344 844 3899
- For customers within Ireland: 01 289 8333
- Monday - Friday 9:00 am - 5:00 pm (Excluding public holidays).
- For further support on your product, please visit our website:
www.panasonic.co.uk

Direct Sales at Panasonic U.K.

- Order accessory and consumable items for your product with ease and confidence by phoning our Customer Communications Centre Monday - Friday 9:00am - 5:00pm (Excluding public holidays).
- Or go on line through our Internet Accessory ordering application at www.pas-europe.com.
- Most major credit and debit cards accepted.
- All enquiries transactions and distribution facilities are provided directly by Panasonic U.K.
- It couldn't be simpler!
- Also available through our Internet is direct shopping for a wide range of finished products. Take a browse on our website for further details.

Reading the Operating Instructions (PDF format)

More detailed operating instructions are available in “Operating Instructions for advanced features (PDF format)”. To read it, download it from the website.

<https://panasonic.jp/support/dsc/oi/FZ80D/index.html>



- Click the desired language.
- You will need Adobe Reader to browse or print the Operating Instructions (PDF format). You can download and install a version of Adobe Reader that you can use with your OS from the following website. (As of June 2024)
<http://www.adobe.com/products/acrobat/readstep2.html>

- SDXC Logo is a trademark of SD-3C, LLC.
- The terms HDMI, HDMI High-Definition Multimedia Interface, HDMI Trade dress and the HDMI Logos are trademarks or registered trademarks of HDMI Licensing Administrator, Inc.
- USB Type-C® and USB-C® are registered trademarks of USB Implementers Forum.
- Adobe is a trademark or registered trademark of Adobe Systems Incorporated in the United States and/or other countries.
- HDAVI Control™ is a trademark of Panasonic Holdings Corporation.
- “AVCHD”, “AVCHD Progressive” and the “AVCHD Progressive” logo are trademarks of Panasonic Holdings Corporation and Sony Corporation.
- Manufactured under license from Dolby Laboratories. Dolby, Dolby Audio, and the double-D symbol are trademarks of Dolby Laboratories Licensing Corporation.
- Pentium is a trademark of Intel Corporation in the U.S. and/or other countries.
- Windows is either registered trademark or trademark of Microsoft Corporation in the United States and/or other countries.
- iMovie, Mac and macOS are trademarks of Apple Inc., registered in the U.S. and other countries.
- QR Code is a registered trademark of DENSO WAVE INCORPORATED.
- This product uses “DynaFont” from DynaComware Corporation. DynaFont is a registered trademark of DynaComware Taiwan Inc.
- Other names, company names, and product names mentioned in these instructions are trademarks or registered trademarks of the companies concerned.



This product incorporates the following software:

- (1) the software developed independently by or for Panasonic,
- (2) the software owned by third party and licensed to Panasonic,
- (3) the software licensed under the GNU General Public License, Version 2.0 (GPL V2.0),
- (4) the software licensed under the GNU LESSER General Public License, Version 2.1 (LGPL V2.1), and/or
- (5) open source software other than the software licensed under the GPL V2.0 and/or LGPL V2.1.

The software categorized as (3) - (5) are distributed in the hope that it will be useful, but WITHOUT ANY WARRANTY, without even the implied warranty of MERCHANTABILITY or FITNESS FOR A PARTICULAR PURPOSE. Please refer to the detailed terms and conditions thereof displayed by selecting [MENU/SET] → [Setup] → [Version Disp.] → [Software info].

At least three (3) years from delivery of this product, Panasonic will give to any third party who contacts us at the contact information provided below, for a charge no more than our cost of physically performing source code distribution, a complete machine-readable copy of the corresponding source code covered under GPL V2.0 or LGPL V2.1, as well as the respective copyright notice thereof.

Contact Information: oss-cd-request@gg.jp.panasonic.com

The source code and the copyright notice are also available for free in our website below.

<https://docs.connect.panasonic.com/oss/>

This product is licensed under the AVC Patent Portfolio License for the personal use of a consumer or other uses in which it does not receive remuneration to (i) encode video in compliance with the AVC Standard ("AVC Video") and/or (ii) decode AVC Video that was encoded by a consumer engaged in a personal activity and/or was obtained from a video provider licensed to provide AVC Video. No license is granted or shall be implied for any other use. Additional information may be obtained from MPEG LA, L.L.C.

See <http://www.mpegla.com>



Manufactured by:

Panasonic Entertainment & Communication Co., Ltd.

1-10-12, Yagumo-higashi-machi, Moriguchi City, Osaka, Japan

Importer for UK:

Panasonic UK, a branch of Panasonic Marketing Europe GmbH

Maxis 2, Western Road, Bracknell, Berkshire, RG12 1RT

Importer for EU:

Panasonic Marketing Europe GmbH

Hagenauer Strasse 43, 65203 Wiesbaden, Germany

Authorized Representative in EU:

Panasonic Marketing Europe GmbH

Panasonic Testing Centre

Winsbergring 15, 22525 Hamburg, Germany

Panasonic Entertainment & Communication Co., Ltd.

Web Site: <http://www.panasonic.com>

© Panasonic Entertainment & Communication Co., Ltd. 2024